

---

# **FusionAmp**

---

## **User Guide**





# FusionAmp, an introduction

Thank you for purchasing the Hypex FusionAmp Plate Amplifier, powered by our NCORE technology.

This FusionAmp can be the basis of a powerful active subwoofer, a two-way or a three-way monitor. The FusionAmp family consists of the following models:

FusionAmp One-Way models:

- **FA251**, 1x250W
- **FA501**, 1x500W

FusionAmp Two-Way models:

- **FA122**, 2x125W
- **FA252**, 2x250W
- **FA502**, 2x500W

FusionAmp Three-Way models:

- **FA123**, 2x125W + 100W Tweeter
- **FA253**, 2x250W + 100W Tweeter
- **FA503**, 2x500W + 100W Tweeter

Please read the safety instructions on the next page before installing and/or operating the module.

Please note the different models. This guide describes the one-way and multi-way models. In addition to the analogue inputs, the one-way models have a high level analogue input, whereas the multi-way models have digital inputs instead.

This user guide covers the general user instructions for these models. For detailed 3D CAD models, please refer to our website. In addition to the 3D CAD files, we have 2D drawings and an FAQ section, with a lot of additional support material.

Included in the box

- The FusionAmp
- This user guide
- Speaker connection cable(s)

One-Way models:

- 4 way, pluggable terminal block, 5.08 mm

## Default filter

To protect your valuable drivers, the DSP does not contain a filter out of the box. A filter needs to be configured and uploaded using Hypex Filter design (HFD) software before the FusionAmp will produce an output signal. Please refer to the online HFD manual for more information.

# Table of Contents

Chapter	Page
Introduction, Table of contents	3
Safety precautions	4
Getting started	5
Fusion Accessories	5
Features	6-7
Using the remote (optional)	8
Example applications	8-9
Connections one-way models	10
Connections multi-way models	11
Installation	12-13
Connecting the speakers	14
FusionAmp IR Receiver kit	15
System information	16
Advanced system information	17
Troubleshooting	18
Frequently asked questions	18
Support	18
Warranty	19
Disclaimer	19
Revisions	19
Notes	19

# Safety precautions

**This module operates at mains voltage and carries hazardous voltages at accessible parts. These parts may never be exposed to inadvertent touch. Observe extreme care during installation and never touch module of the unit while it is connected to the mains. Disconnect the unit from the mains and allow all capacitors to discharge for 10 minutes before handling it.**

**Damage due to inappropriate handling is not covered by warranty. This product has no user-serviceable parts.**

**Warning:** To reduce the risk of fire or electric shock, do not expose this device to rain or moisture.

## Précautions de sécurité

**Ce module est sous tension secteur et certaines de ses pièces accessibles sont sous une tension dangereuse. Ces pièces doivent dans tous les cas être protégées contre contacts accidentels. Lors de l'installation, une prudence extrême s'impose. Ne jamais toucher les pièces du module quand celui-ci est relié au secteur. Isoler l'appareil du secteur et attendre 10 minutes pour laisser à tous les condensateurs le temps de se décharger avant de le manipuler.**

**Les dommages causés par un usage non approprié sont exclus de la garantie.**

**Ce produit ne contient aucune pièce devant être entretenue par l'utilisateur.**

**Avertissement:** Pour réduire les risques de choc électrique, ne pas exposer cet appareil à la pluie ou l'humidité.



Attention: Observe precautions for handling electrostatic sensitive devices. This module uses semiconductors that can be damaged by electrostatic discharge (ESD).





The lightning flash with arrowhead symbol within an equilateral triangle is intended to alert the user to the presence of uninsulated "dangerous voltage" within the product's enclosure, that may be of significant magnitude to constitute a risk of electric shock to persons.





The exclamation point within an equilateral triangle is intended to alert the user of the presence of important operating and maintaining (servicing) instructions in the literature accompanying the appliance.

 This product must be earthed.

 Apparattets stikprop skal tilsluttes en stikkontakt med jord, som giver forbindelse til stikproppens jord.

 Laitte on liitettävä suojakoskettimilla varustettuun pistorasiaan.

 Apparatet må tilkoples jordet stikkontakt.

 Apparatens skall anslutas till jordat uttag.

1. Read these instructions.
2. Keep these instructions.
3. Heed all warnings.
4. Follow all instructions.
5. Do not use this apparatus near water.
6. Clean only with a dry cloth.
7. Natural convection should not be impeded by covering the module (apart from the end applications housing). Do not block any ventilation openings. Install in accordance with the manufacturer's instructions.
8. Do not install near any heat sources such as radiators, heat registers, stoves, or other apparatus (including amplifiers) that produce heat.
9. Do not defeat the safety purpose of the protective earth / grounding mains inlet. Protective earth is provided for your safety.
10. Protect the power cord from being walked on or pinched particularly at plugs, convenience receptacles, and the point where they exit from the apparatus.
11. Only use attachments/accessories specified by the manufacturer.
12. Unplug this apparatus during lightning storms or when unused for long periods of time.
13. Refer all servicing to qualified service personnel. Servicing is required when the apparatus has been damaged in any way, such as power-supply cord or plug is damaged, liquid has been spilled or objects have fallen into the apparatus, the apparatus has been exposed to rain or moisture, does not operate normally, or has been dropped.
14. This apparatus shall not be exposed to dripping or splashing, and no object filled with liquids, such as vases or beer glasses, shall be placed on the apparatus.
15. Do not overload wall outlets and extension cords as this can result in a risk of fire or electric shock.
16. This apparatus has been designed with Class-I construction and must be connected to a mains socket outlet with a protective earthing connection.
17. This apparatus has been equipped with a rocker-style AC mains power switch. This switch is located on the rear panel and should remain readily accessible to the user.
18. The MAINS plug or an appliance coupler is used as the disconnect device, so the disconnect device shall remain readily operable.
19. Do not run any cables across the top or the bottom of the module. Apply fixtures to cables to ensure that this is not compromised.
20. Before using this product, ensure all cables are correctly connected and the power cables are not damaged. If you detect any damage, do not use the product.
21. Changes or modifications not expressly approved by Hypex Electronics will void compliance and therefore the user's authority to operate the equipment.
22. Service or modifications by any person or persons other than by Hypex Electronics authorized personnel voids the warranty.



Correct disposal of this product: This symbol indicates that this product should not be disposed of with your household waste, according to the WEEE directive (2012/19/EU) and your national law. This product should be handed over to an authorized collection site for recycling waste electrical and electronic equipment (EEE). Improper handling of this type of waste could have a possible negative impact on the environment and human health due to potentially hazardous substances that are generally associated with EEE. At the same time, your cooperation in the correct disposal of this product will contribute to the effective usage of natural resources. For more information about where you can drop off your waste equipment for recycling, please contact your local city office, waste authority, or your household waste disposal service.

## Getting Started

We understand you want to experience the sound of your new FusionAmp powered speaker as quickly as possible. Therefore, we have made you this 'roadmap to success'.

### Selecting your Fusion Amps:

Before you order your FusionAmps, you have to select the correct version that fits your design. Take a look at the example applications in this manual and write down your requirements.

### Ordering your Fusion Amps:

Once you know which FusionAmps you need, you can order them from our online store. Cables to connect to your woofers and tweeters are included. Other cables are not included. If you do not have mains cables or a mini USB cable, you can also add those to your order. Additionally we offer a range of high quality audio cables to make sure you have all the cables you need.

### Designing and loading a filter:

Since the FusionAmp's DSP does not contain a filter by default, you need to get started with HFD. This free software can be downloaded from our website. You can start getting acquainted with the software, even without a Hypex product connected. An elaborate guide on how to design the filters can be found on our website.

### Installing the FusionAmp in your cabinet:

For best performance, the FusionAmp should be installed in a sealed compartment of your speaker cabinet. This guide includes basic dimensions for installation. Refer to the chapter 'Installation' for instructions. Detailed 3D models and 2D drawings can be found on our website, to assist you in designing the speaker cabinet.

### Start listening!

Once the filters are uploaded to the FusionAmp and the speaker cabinet is fully assembled, you can start listening and tweaking your sound experience.

## Fusion Accessories

With your FusionAmp you may need some additional accessories. The following items can be ordered separately:

### FusionAmp IR Receiver Kit

All modules can be extended with the Fusion IR Receiver Kit. It contains a PCBA with IR receiver and bi-colour LED, and the necessary cable (125cm). This kit is required in master devices if the Hypex remote is to be used. This kit can also be added in slave devices, but the IR functionality will be disabled. The green LED acts as on-off indicator, the red LED mirrors the protect indicator.

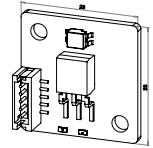

### Hypex Remote

The Hypex Remote can be used in combination with the Fusion IR Receiver Kit to control volume, source, presets and put the system into standby.



### FusionAmp Mounting Screws

The Fusion Amp must be mounted into the speaker cabinet with 8 or 10 screws. This set contains 10 self-tapping, black, Phillips head screws, 4.3x25.4 mm.



### USB 2.0 Cable

USB Type A Plug - Mini USB Type B Plug,

### Power cord EU

IEC 60320 C13 - IEC Type F

Used in: Germany, Austria, the Netherlands and Spain among others.

### Power cord UK

IEC 60320 C13 - IEC Type G

Used in: UK, Ireland, Cyprus, Malta, Malaysia, Singapore, Hong Kong.

### Power cord AU/NZ

IEC 60320 C13 - IEC Type I

Used in: Australia, New Zealand, Papua New Guinea, Argentina, China.

### Power cord USA

IEC 60320 C13 - IEC Type B / NEMA 5-15P

Used in: North and Central America, Japan.

### Hypex Filter Design

If you need a physical copy of Hypex Filter Design, you can order a CD containing HFD from our online store. HFD is also available for free download.

## Features

### Fan control

The FA502 and FA503 feature an advanced cooling system. The software monitors the signal input and module temperature. A proportional-integral algorithm controls the fan speed. This ensures sufficient cooling when needed and quiet operation when desired.

### Source select

Automatic source select automatically locks to the first available source. The input scanner scans in the following order and loops:

# One-way models:

XLR | RCA | High Level Input

# Multi-way models:

AES | S/PDIF | Optical | XLR | RCA.

The source can also be selected manually. Configure manual or automatic source selection in HFD.

### Daisy-chaining

The balanced analogue input can be daisy chained using the XLR through connector. This output XLR is directly connected to the input XLR. The maximum number of chained modules is limited by the source's capabilities.

Multi way versions:

The FusionAmp can also be daisy chained in the digital domain. The signal on the AES and S/PDIF output is the signal of the current selected digital input.

Note: there is no link between analogue and digital domains. Analogue input signal can not be routed to digital output and vice versa.

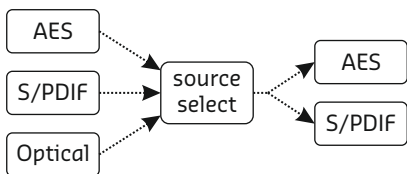

### Signal detect

Instead of a trigger input, the FusionAmp features a signal detect function. Depending on the selected power mode (explained below), the FusionAmp scans for input signal and enables it if it detects or locks on to a signal. Signal detect can be configured in HFD.

Note: signal detect overrides on/off control via IR remote control.

### Auto-shutdown

In addition to signal detect, the FusionAmp can automatically switch off if there is no input detected on any of the inputs configured with signal detect. This feature can be configured in HFD.

### Power modes

# Ultra-low power

Meets 2013 ERP Lot 6 0.5W. In this mode the FusionAmp scans for analogue input only. If an analogue input signal is detected, the FusionAmp automatically turns on.

# Low power

In addition to ultra-low power mode, which only scans for analogue input, this mode also scans the digital inputs for signal. Multi-way only.

# Wake up on line

In this mode, the FusionAmp is always on, when connected to mains.

In ultra-low or low power mode, the FusionAmp can also be enabled by pressing the select button or via the optional Hypex Remote. Power modes can be configured in HFD.

### Bridge-tied load

The multi-way Fusion Amp can be configured for BTL. BTL allows two amplifiers to be combined to double the output power. This features can be configured in HFD. Speaker connection must be done according to the description in chapter: installation.

### Soft-clip

Soft-clip minimizes audible distortion if the amplifier is over-driven. By default, the FusionAmp DSP has soft-clip disabled.

Every limiter has its effect on audio quality. For optimal sound quality, one may want to leave this feature disabled. Hardware clip detection is always enabled.

If the FusionAmp is driven into clipping (soft or hard) the protect indicator lights up. Hardware clipping only indicates when the amplifiers are over driven. It does not protect the amplifier, nor your speakers.

Soft-clip can be configured using HFD. To correctly configure soft-clip, the speaker impedance and maximum output power parameters need to be set. By default, soft-clip is configured to deliver maximum power into 4Ω load impedance.

## Thermal protection

All amplifiers produce heat, even highly efficient Class D amplifiers. Therefore, the FusionAmp has an internal thermal protection.

### # Thermal limiting

If the amplifier is reaching its maximum temperature, the output is lowered by 6dB. Additionally the protect indication starts blinking once every second.

### # Thermal shutdown

If the maximum temperature is reached, the amplifier is switched off to protect it from damage. Additionally the protect indication starts blinking twice every second.

When the amplifier has cooled down to a safe operating temperature, the thermal protection resets and the FusionAmp resumes to normal operation.

To prevent overheating, install the FusionAmp according to the installation instruction. Never cover the ventilation holes or place the FusionAmp near a heat source.

## Critical failure

If a critical failure is detected, i.e. a DC error, the amp shuts down immediately and the protect indication will be enabled. A critical error is latching, meaning only a power cycle might solve the issue. If a power cycle does not work, contact Hypex support.

## Gain and volume

The FusionAmp has an advanced gain structure. First of all, we distinguish a master gain (referred to as 'volume'). This volume can be adjusted with HFD, via the remote link, or with the Hypex remote.

Secondly, each FusionAmp as a whole, can have an offset to the master volume.

Thirdly, each filter can have an offset to this volume. This can be used to match less sensitive woofers with more sensitive woofers.

Finally, the one-way models have a manual gain offset, since these models are meant for use as a subwoofer, one might want to add a little extra punch at a certain moment.

To prevent the FusionAmp to power up at maximum volume, an optional startup volume (master) can be configured in HFD.

## Filter protection

The presets loaded in the FusionAmp can be password protected, so that unauthorized persons can not overwrite the configuration. This feature can be configured in HFD. Use this function with caution. If you configure this function, you will be asked to enter an email address. This address is stored in the FusionAmp's memory. If you have lost your password, a reset code can be requested which will be sent to this email address.

## Preset selection

The FusionAmp can store up to three presets, each containing:

- Source
- Filter
- Gain offset
- Source lock

These presets can be configured in HFD. The presets filter, gain and clip mode are static and can only be configured in HFD. The filter of the specific presets can be specifically designed for e.g. audiophile listening, party or any other purpose. Source selection is dynamic and stores the last selected source in memory of the selected preset. If a different preset is selected, the source is switched to the particular input of that preset, provided that the source is not locked. Master volume stays equal while switching presets, gain-offset is added, if this is configured in the preset.

## Hypex Filter Design (HFD)

HFD is a free software tool needed to configure the FusionAmp. To protect your valuable drivers, the DSP does not contain a filter out of the box. A filter needs to be configured and uploaded before the FusionAmp will produce an output signal.

HFD can be used to measure the frequency response of the speaker and this information can be used to design your filter. 15 biquad filters are available per amplifier channel.

A more elaborate guide is available on our website, to guide you to a fully configured FusionAmp.

The most recent version of HFD is available for download on our website or, if you would like a physical copy, add a CD to your order.



## Using the remote (optional)

All modules can be extended with the Fusion IR Receiver kit. This set contains a PCBA with IR receiver and bi-colour LED, and the necessary cables. Additionally you need a Hypex Remote. Installation instructions for this kit are supplied with the product.

### Principle of master and slave.

To work with the remote feature, you need to understand the principle of master and slave modules. In principle, the module to which the Fusion IR Receiver Kit is connect, should be configured as master. Additionally, the other FusionAmps in your setup should be configured as slave.

The IR receiver PCBA can be used in both master and slave devices, only in slave devices the IR functionality is disabled. The bi-colour LED can then be used to indicate the status of the particular slave device. Take care to correctly configure master and slaves to prevent unexpected behaviour.

### How to link the slave modules to the master?

The S/PDIF I/O is utilized to communicate between the modules. The master module modulates a communication link on to the S/PDIF I/O. Use a decent quality 75 ohm coaxial cable to link the modules. The maximum total cable length should be kept under 25 meter. A maximum of three slave modules can be connected to one master. Refer to the application examples for more information.

### What to do with a mixed model setup?

If a mixed setup is created (one-way models mixed with multi-way models) the master should be a multi-way model. Since a mixed configuration has conflicting inputs (digital vs high-level), the one-way models are muted if a digital source is selected at the master. If this is undesirable, consider a two-way model in BTL or dual-mono as subwoofer amplifier.

### Source lock

To prevent a master module from changing the source selection on a slave module, the source can be locked for each preset using the Source lock option in HFD. For example, when the slave is linked to the master via an SPDIF cable, the source needs to be fixed to SPDIF to prevent signal loss when the master is switched to a different source.

## Application examples

A couple of examples are given. These examples are meant as reference. Other configurations are also possible. Read all examples, since valuable principles are explained in different examples. These examples assume you have read the other chapters in this guide. In the schematic drawing, the remote link is depicted as a dotted line: .....> Other connections are depicted as dashed line and may be digital, analogue, balanced ore unbalanced.

### Setup with preamp or directly from source

This is the most simple setup. Use your (existing) preamp for source selection, volume etc. The FusionAmps can be connected analogue or digitally, depending on your preamp. This setup can be easily expanded with additional FusionAmp speakers. This setup can be used with, or without a optional remote.

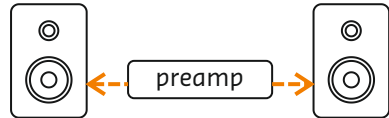

### Without a preamp, with multiple sources

This example features two multi-way models that are equipped with the remote kit. The two FusionAmps are linked via the S/PDIF I/O for remote communication and this also functions as a daisy chain for the digital domain. If toslink is selected in the master(1), the slave(2) can be configured to listen to the S/PDIF daisy chain.

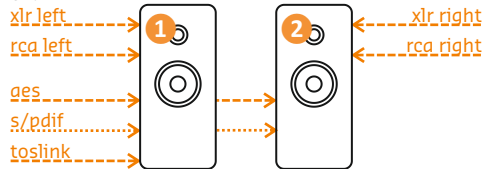

### Multi-way top speakers, one-way subwoofers

This example is connected using analogue XLR. The left and right channels are daisy chained per channel. This setup can be used with, or without remote kit.

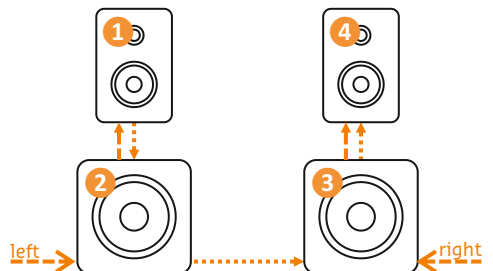



### Multi-way top speakers with dual mono sub.

You can choose for a full-digital setup here. The master (1) can be used as input and can be daisy chained to the other modules. A digital signal carries both left and right channel. Using HFD the channel can be selected and filters need to be configured accordingly. Module 2,3 and 4 must be set as slave.

You can also choose for a BTL setup in the subwoofers, using only one driver and the multi-way FusionAmp configured as BTL.

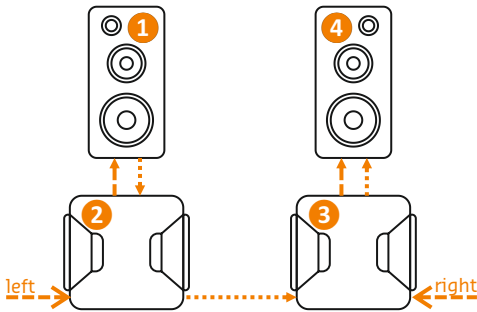

### High level input

In this setup we add one (or two) FA one-way models to act as active subwoofer. If only one subwoofer is added, both left and right channel should be connected to the respective high-level input of that one subwoofer. If two subwoofers are added, connect them in respect to the corresponding channel.

In this setup a remote kit does not add much value, since volume is controlled by the existing amplifier, just as source selection. The gain of the subwoofer(s) can be adjusted using the gain control knob.

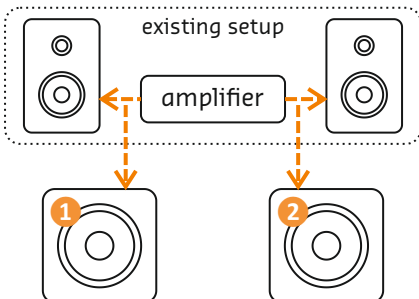

## Connections one-way models

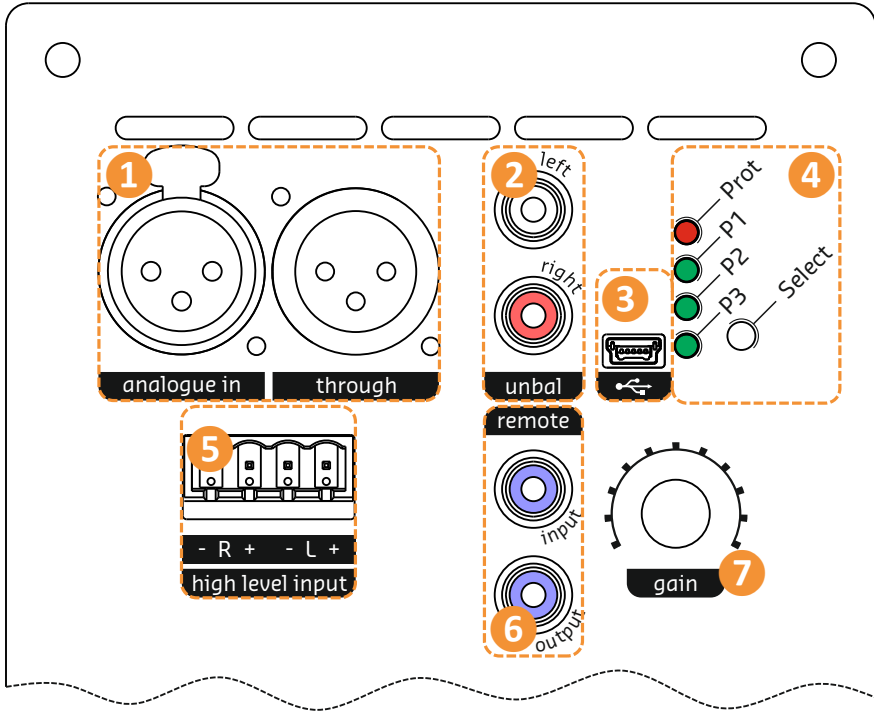

### 1 **Balanced analogue I/O:**

Balanced analogue input and through output. Refer to chapter Technical Specifications for more information.

### 2 **Unbalanced analogue input:**

A stereo input signal is internally mixed to mono. For mono use, simply connect only the relevant channel.

### 3 **USB:**

Can be used to configure the FusionAmp. This connection does not support USB audio.

### 4 **LED Indicators and button:**

Clip or Limit indication

■ Prot: Random blinking: Amplifier limits

Steady on: Fatal / DC Error

Blink once per second: High temperature

Blink twice per second: Over temperature

Preset:

■ P1: Preset 1 selected

■ P2: Preset 2 selected

■ P3: Preset 3 selected

### **Preset selection:**

The selected preset LED is lit by default. To change the selected preset, short press the select button.

When the module is muted, the preset LED will blink slowly.

### 5 **High level input:**

The high level input can be used to connect to your existing amplifier if no pre-out is available.

### 6 **Remote I/O:**

Connects to the remote of other FusionAmps.

### 7 **Gain adjust:**

A manual offset can be set using the gain knob. This is especially useful in subwoofer applications: for instance to add that little bit of extra punch during your favourite action movie.

By default, the gain offset can be adjusted by 12 dB in both directions. The volume of the one-way model can be set using HFD or via the optional remote.

## Connections multi-way models

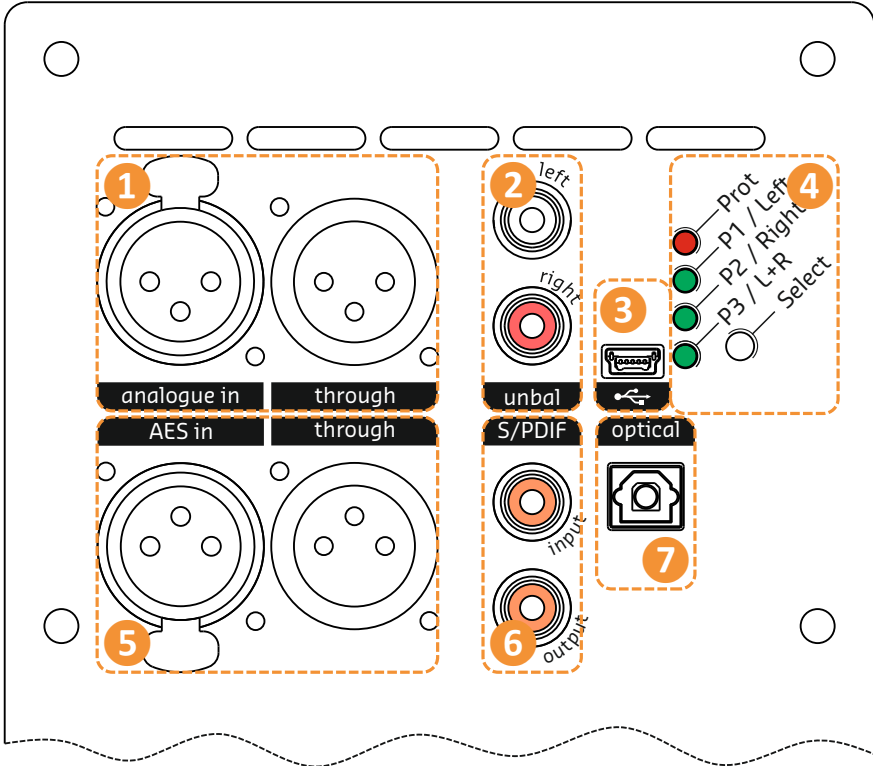

### 1 **Balanced analogue I/O:**

Balanced analogue input and through output. Refer to chapter Technical Specifications for more information.

### 2 **Unbalanced analogue input:**

A stereo input signal is internally mixed to mono. For mono use, simply connect only the relevant channel.

### 3 **USB:**

Can be used to configure the FusionAmp. This connection does not support USB audio.

### 4 **LED Indicators and button:**

Clip or Limit indication

■ Prot: Random blinking: Amplifier limits  
Steady on: Fatal / DC Error  
Blink once per second: High temperature  
Blink twice per second: Over temperature

Preset:

■ P1: Preset 1 selected  
■ P2: Preset 2 selected  
■ P3: Preset 3 selected

### **Preset selection:**

The selected preset LED is lit by default. To change the selected preset, short press the select button. When the module is muted, the preset LED will blink slowly.

### **Digital channel selection:**

Digital signal carries both left and right signal. Therefore, the desired channel can be configured using HFD.

When a digital source is selected, the current channel setting can be displayed by holding the select button for 3 seconds until the selected channel mode starts blinking.

■ Left: Left digital channel selected  
■ Right: Right digital channel selected  
■ L/R: Both digital channels mixed into mono

To change the selected channel mode, hold the select button after the long press. Every 1.5 seconds, the channel mode is switched.

### 5 **AES digital I/O:**

AES3 (2-channel digital audio)

### 6 **S/PDIF digital I/O:**

S/PDIF (2-channel digital audio)

### 7 **EIAJ optical:**

EIAJ optical / Toslink (2-channel digital audio)

# Installation

## Dimensions

	A	B	C	D	E	
FA122	315	120	55	291	96	mm
FA123	360	120	55	336	96	mm
FA251	280	120	55	256	96	mm
FA252	315	135	55	291	111	mm
FA253	360	135	55	336	111	mm
FA501	280	135	55	256	111	mm
FA502	380	150	90	356	126	mm
FA503	420	150	90	396	126	mm

Size D and E is the recommended milling dimension for mounting the FusionAmp inside your speaker cabinet. This leaves 12mm on each side for the mounting screws.

## Weight:

<b>FA122:</b>	815 g
<b>FA123:</b>	955 g
<b>FA251:</b>	725 g
<b>FA252:</b>	1000 g
<b>FA253:</b>	1145 g
<b>FA501:</b>	925 g
<b>FA502:</b>	2150 g
<b>FA503:</b>	2275 g

Detailed dimensions are available on our website. We supply 3D models in .STEP, .ESAM and 3D PDF. Furthermore, 2D milling and drilling patterns are available. Please verify all drawings with your model before you start milling!

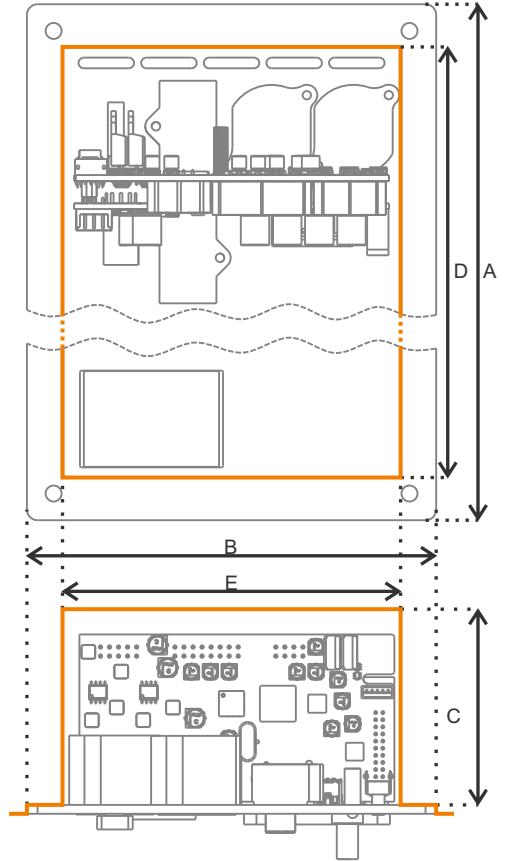

### Installation instruction

For your own safety: never remove the protective earth connections. Always connect the FusionAmp to a power outlet with protective earth. Always disconnect the FusionAmp if serviced.

The FusionAmp is not airtight. For optimal performance the module should be installed in a separate compartment in the speaker cabinet.

All possible conductive parts of the enclosure should be connected to protective earth. Keep a minimum clearance of 3 mm to all these possible conductive parts.

### Compartment requirements

The compartment in which the FusionAmp is fitted should be constructed of V-1 class material (flammability standard). Additionally, a layer of V-0 class material should be fitted, on the inner side of the cabinet, at both sides of the amplifier module. Alternatively, the whole compartment can be made of V-0 class material or better. Note: this information is given as guideline only. For exact measures, please consult EN-IEC 62368-1:2014, chapter 6.

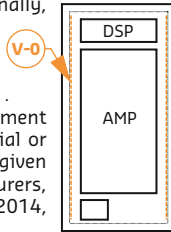

### Mounting angles

The FusionAmp is designed to be mounted in vertical or horizontal position. The FusionAmp may be tilted 45° in both directions as depicted. Vent holes should not be covered and free convection should not be impeded.

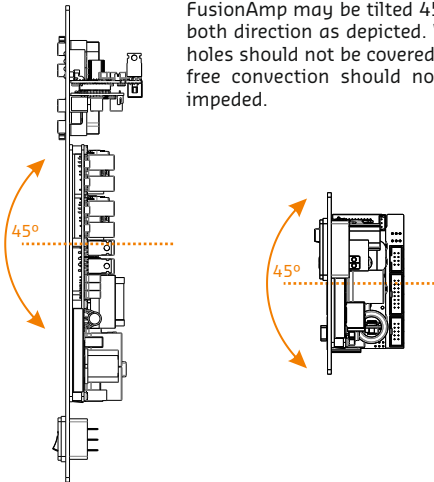

# Connecting speakers

## General recommendations

For best performance, Hypex recommends to twist the speaker wires per channel. Route the speaker cables in such a way that the cables and connectors are not stressed. Preferably route the speaker cable away from the module, especially the power supply part.

## One-way model

The speakers must be connected using the included cable assembly. Connect to J5 on the main module. If one woofer is connected, one can remove wire 1 and 2, or bi-wire the speaker by combining wire 1-3 and 2-4.

## Two-way model

The speakers must be connected using the included cable assembly. Connect to J5 on the main module.

### Single ended:

Ch1: Red(+) / Black(-), Ch2: Blue(+) / Gray(-).

### BTL:

For BTL, the second channel needs to be inverted using HFD. Connect the woofer between red(+) and blue(-).

## Three-way model

Connect the main amplifiers in the same way as the two-way model. Additionally connect the third channel using the included cable assembly. This main module can also be configured as BTL.

### Cable part#: Z4A125L1

125cm, 1.5mm<sup>2</sup> speaker connection cable, included in all models:



### Cable part#: Z2A125L1

125cm, 1.5mm<sup>2</sup> included in three-way model:



Extension J5: three-way models

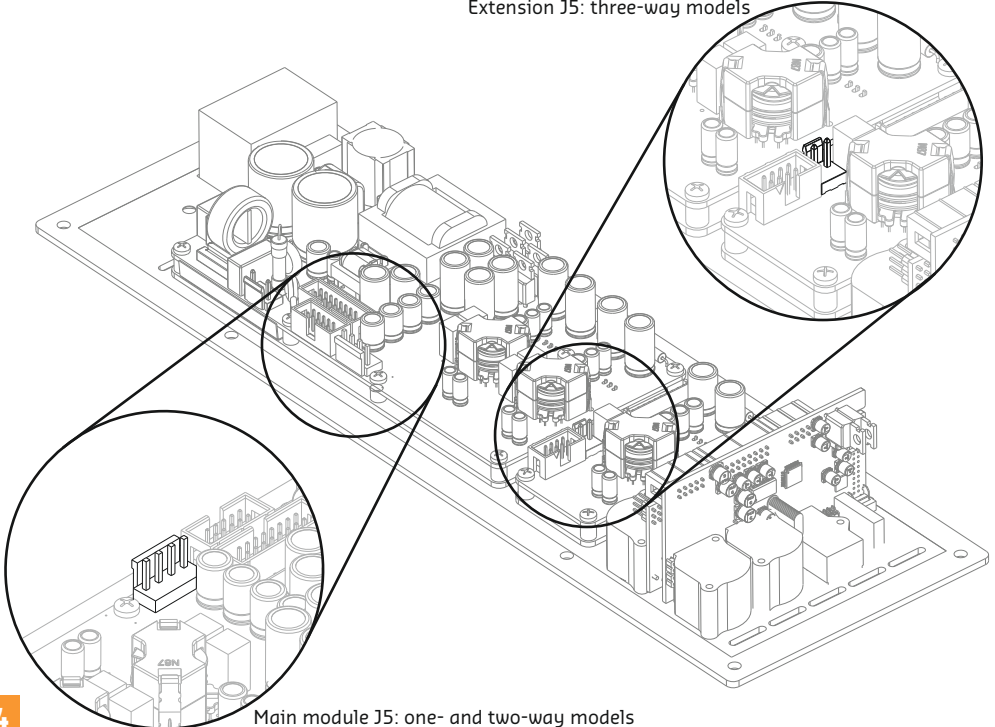

Main module J5: one- and two-way models

# FusionAmp IR Receiver kit

## Contents

The FusionAmp IR Receiver kit consists of the following:

- PCB assembly
- Tinted perspex sheet with self-adhesive backing
- Light pipes, 3x25.4 mm and 5x25.4 mm
- Cable, 125 cm

## LED indicator

The bi-colour LED can indicate the following:

- Green: Unit on
- Green, flashing: IR command received
- Green, red flashing: signal clipping
- Green, slowly blinking: output muted
- Red: fatal error, switched off
- Red, blinking 1x/sec: high temperature, output limited
- Red, blinking 2x/sec: over temperature, output off
- Off: unit in standby

## Installation

The IR Receiver kit can be mounted either to the inside or the outside of the speaker cabinet. Connect the cable to J15 on the input board.

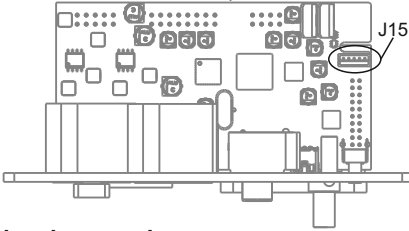

## Interior mounting

The PCB assembly is mounted to the inside of the speaker cabinet using two screws (not included). The light pipes are used to extend the LED and IR receiver to the outside of the cabinet.

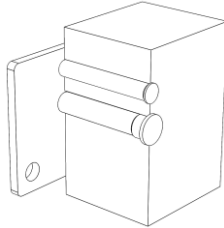

## Exterior mounting

The PCB assembly is mounted to the outside of the cabinet using the adhesive backing. The perspex sheet is used to provide a neat cover for the PCB assembly.

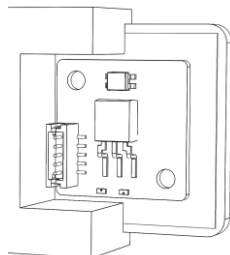

## Dimensions

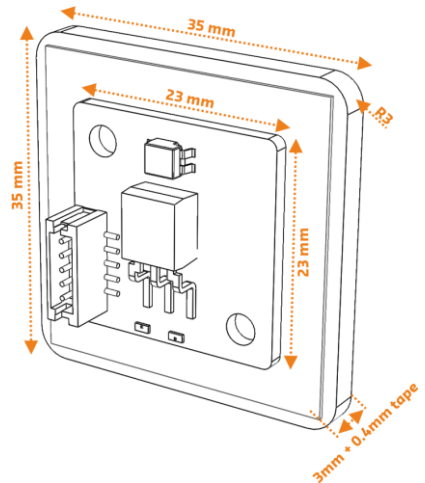
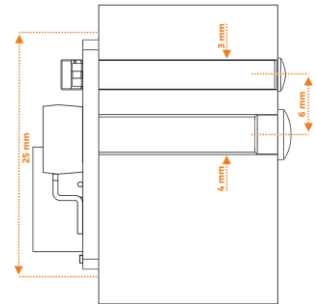
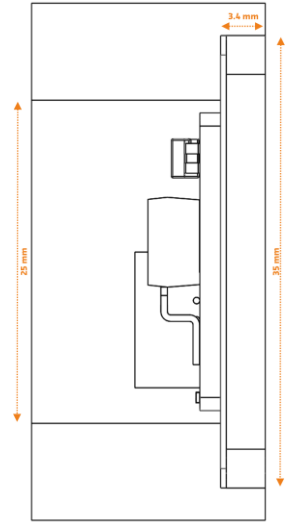

# System information

## Auto switching Line input power

Low Line input voltage: 100-120Vac  $\pm$ 10%  
 High Line input voltage: 200-240Vac  $\pm$ 10%  
 Line input frequency: 47 - 63 Hz  
 Connector: 3-pin IEC 250Vac, 10A male.

## Input power:

FA122, FA123, FA251: 350W max  
 FA252, FA253, FA501: 650W max  
 FA502, FA503: 1200W max

## Output power in 4 Ohm at < 0,1% THD+N:

FA122: 2x 125Wrms  
 FA123: 2x 125Wrms + 1x 100Wrms  
 FA251: 1x 250Wrms  
 FA252: 2x 250Wrms  
 FA253: 2x 250Wrms + 1x 100Wrms  
 FA501: 1x 500Wrms  
 FA502: 2x 500Wrms  
 FA503: 2x 500Wrms + 1x 100Wrms

## Dimensions and weight

Refer to the installation instruction page.

## Ambient temperature

Max. 35 °C

## DSP Filters:

15 biquads per channel. A one-way Fusion Amp has 15 biquads, a two-way has 2x15 biquads and a three-way has 3x15 biquads. Amplifiers configured in BTL still have 15 biquads available.

## Maximum delay:

19,2ms per channel.

## Chip specification:

DSP: ADAU1450  
 ADC: AK5554  
 DAC: Ak4454  
 SRC: SRC4382, max. sampling frequency 192kHz (optical 96kHz)

## Performance:

MBW=20kHz (20Hz-20Khz), unweighted, all filters set to unity, gain adjust 0dB, unless otherwise specified.  
 SNR AD/DA -109dB  
 SNR DA -111dB  
 THD(D+N)(at -1dBFS) AD/DA -100dB  
 THD(D+N)(at -1dBFS) DA -102.5dB

# Block diagram

The block diagram gives an overview of the technical architecture of the FusionAmp. Depending on the model, the available inputs vary. All models have analogue balanced and unbalanced input. The one-way models have an additional high level input. The multi-way models feature digital IO. The IR receiver and remote are optional.

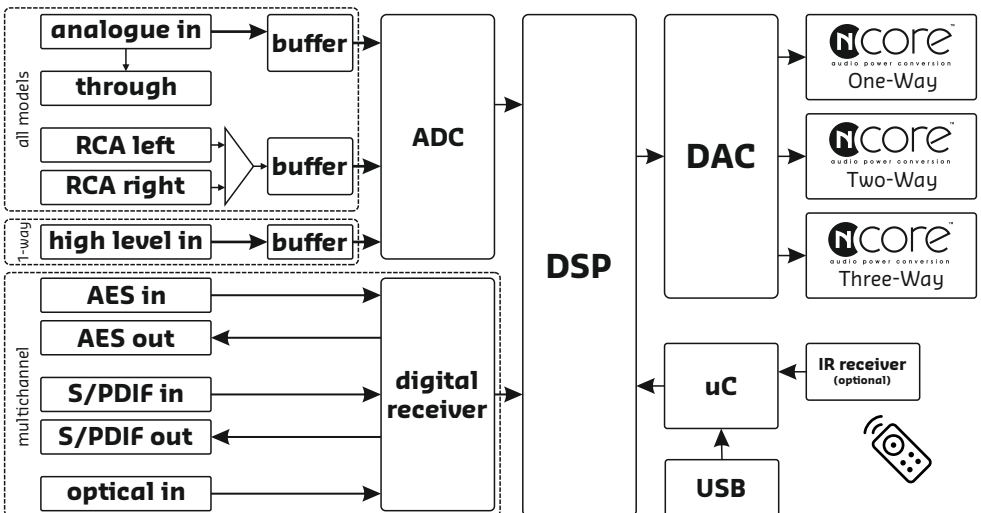



# Advanced system information

This information is given for reference and to guide you in connecting your FusionAmp in the correct way. Do not modify the internal wiring of the FusionAmp.

### Balanced XLR connection:

Neutrik NC3FXX-B or -BAG (female)  
Neutrik NC3MXX-B or -BAG (male)

Pinout:

Pin 1: Shield  
Pin 2: Positive (+ or hot)  
Pin 3: Negative (- or cold)

Input impedance:

XLR Analogue: 44 kOhm DM  
2.2 MOhm CM  
AES: 110 kOhm

### Unbalanced RCA connections:

Hypex RCA set Gold or Hypex RCA set Rhodium

Pinout:

Sleeve: Shield (Ground)  
Tip: Positive (+ or hot)

Input impedance:

RCA Analogue: 54 kOhm  
S/PDIF: 75 kOhm

### High level input:

Phoenix contact MSTB 2,5/ 4-ST-5,08  
Maximum input level: 50Vrms, 70Vp

### Speaker connectors:

With your FusionAmp, a standard cable set is included to connect your speakers to the amplifiers. If you wish to make your own cables, please use the following connectors to connect to the amplifiers. Never solder directly to the connectors of the modules as this will void your warranty.

Cable part main amplifier: VHR-4N  
Cable part tweeter amplifier: VHR-2N  
Required contact pins: SVH-41T-P1-1

Pin 1: Ls2- Cold Output  
Pin 2: Ls2+ Hot Output  
Pin 3: Ls1- Cold Output  
Pin 4: Ls1+ Hot Output

### Gain jumper (advanced)

This is an advanced modification. If you are not familiar with delicate soldering or you do not feel confident doing this, please ask an expert for assistance.

Three very small solder jumpers (one for XLR and two for RCA) are located on the bottom side of the upper PCBA. These can be soldered to increase the input sensitivity per analogue input. By default, the jumpers are not soldered.

XLR:

- un-set: 18 dBu 6.15 Vrms
- set: 9 dBu 2.18 Vrms

RCA:

- un-set: 9 dBu 2.18 Vrms
- set: 2 dBu 0.98 Vrms

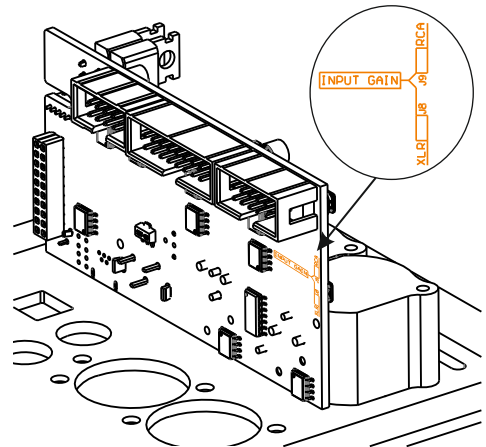

### System requirements:

To configure your FusionAmp, you need a PC with at least the following requirements:

- Windows 7, 8.1 or 10
- A free USB 2.0 or higher port

### On-board amplifiers:

The FusionAmp serie is powered by our range of mains powered Ncore modules. For more information on their performance you can download the relevant datasheet from our website.

**FA122:** NC122MP  
**FA123:** NC122MP + NC100HF  
**FA251:** NC250MP  
**FA252:** NC252MP  
**FA253:** NC252MP + NC100HF  
**FA501:** NC500MP  
**FA502:** NC502MP  
**FA503:** NC502MP + NC100HF

## Troubleshooting

### No power:

- Check the power outlet
- The internal fuse may be blown. This fuse is not user replaceable. Please contact Hypex Electronics for more information about service and repair.

### No Sound

- A protection might be triggered. Is the module overheated? Try cycling the mains power.
- Verify the gain settings.
- Is the DSP muted?
- Check the source signal.
- Check the cables.
- Is there a filter installed in the DSP?

### Poor sound or noise

- Check your filters
- Check if the signal is not inverted. Inverted signals might cause one of your woofers to be out-of-phase.
- Clip?
- Check all connections.

### Hum

Use balanced connections for best system performance.

## Frequently asked questions

**Q** Why is there not a FusionAmp with one NC250MP or NC500MP, with an additional NC100HF?

**A** Since the FA123 and FA253 can be configured in BTL, one can achieve the same result with better audio performance with these models. In addition, e.g. a NC250MP with NC100HF would result in a larger plate compared to a FA252, whilst having a lower specification.

## Support

We continuously work to improve your experience with the FusionAmp. If you have suggestions, remarks or found a bug, please contact us.

If you have problems with your FusionAmp, please first make sure you have the latest version of HFD and you have updated the firmware of your FusionAmp. If you need to update your firmware, please follow the instruction carefully.

Do you need additional assistance with assembling or configuring your FusionAmp?

Visit our website!

The latest datasheets, manuals, 3D models can be found there. Look into our FAQ and if you can not find the answer there, you can also contact us and we will be happy to assist you!

## Limited Warranty

Hypex Electronics warrants this device for a period of two years after the original date of purchase against defects due to faulty workmanship or materials arising from Normal Use of the device. The warranty covers working parts that affect the function of the device. It does NOT cover cosmetic deterioration caused by fair wear and tear, or damage caused by accident, misuse or neglect. Any attempt to modify or take apart the device (or its accessories) will void the warranty.

If you discover a defect, notify Hypex Electronics during the warranty period. Claims under warranty must be supported by reasonable evidence that the date of the claim is within the warranty period. To validate your warranty, please keep your original purchase receipt together with these warranty conditions for the duration of the warranty period. Replacement products claimed under warranty are not entitled to renewed 2-year warranty coverage.

Date of purchase:

## Disclaimer

Hypex Electronics BV, its affiliates, agents, and employees, and all persons acting on its or their behalf (collectively, "Hypex Electronics"), disclaim any and all liability for any errors, inaccuracies or incompleteness contained in any datasheet or in any other disclosure relating to any product.

This subassembly is designed for use in music reproduction equipment only. No representations are made as to fitness for other uses. Except where noted otherwise any specifications given pertain to this subassembly only. Responsibility for verifying the performance, safety, reliability and compliance with legal standards of end products using this subassembly falls to the manufacturer of said end product.

**LIFE SUPPORT POLICY:** Use of Hypex products in life support equipment or equipment whose failure can reasonably be expected to result in injury or death is not permitted except by explicit written consent from Hypex Electronics BV.

## Revisions

Revision	Comment	Date	
00	00xx	Pre-release	01-02-2017
01	00xx	First release	June 2018

## Notes



---

**Hypex Electronics BV**  
Kattegat 8  
9723 JP Groningen, The Netherlands  
+31 50 526 4993  
sales@hypex.nl  
www.hypex.nl

