

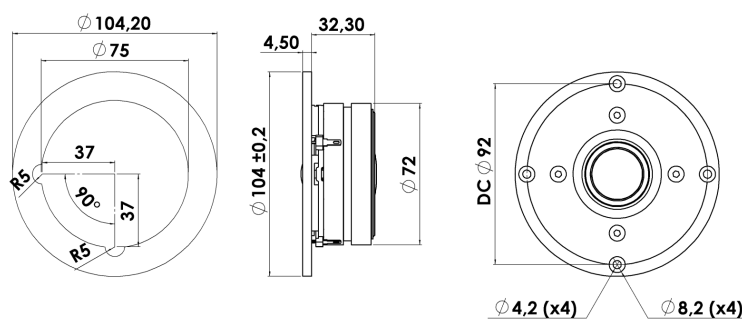

TWEETER

D2608/913000

The Discovery series offer traditional design, superior sound, a solid construction, and a wide range of variants. Combining these elements - plus a wealth of technical features and finesses - it gives our customers the possibility of acquiring a tailor-made Scan-Speak solution with very good performance at a reasonable low price point!



KEY FEATURES:

- Very low mass soft dome diaphragm
- Ferrofluid
- Low resonance Frequency
- Optimized Magnet System with Double magnets
- Fully Vented Motor System for Low compression
- Black Die-Cast Aluminium Face Plate

T-S Parameters

Resonance frequency [fs]	700 Hz
Mechanical Q factor [Qms]	0.51
Electrical Q factor [Qes]	0.65
Total Q factor [Qts]	0.29
Force factor [Bl]	2.6 Tm
Mechanical resistance [Rms]	1.54 kg/s
Moving mass [Mms]	0.18 g
Suspension compliance [Cms]	0.29 mm/N
Effective diaph. diameter [D]	30 mm
Effective piston area [Sd]	7 cm ²
Equivalent volume [Vas]	0.02 l
Sensitivity (2.83V/1m)	91.3 dB
Ratio Bl/√Re	1.10 N/√W
Ratio fs/Qts	2434 Hz

Notes:

IEC specs. refer to IEC 60268-5 third edition.
All Scan-Speak products are RoHS compliant.
Data are subject to change without notice.
Datasheet updated: February 22, 2011.

Electrical Data

Nominal impedance [Zn]	8 Ω
Minimum impedance [Zmin]	6.6 Ω
Maximum impedance [Zo]	10.0 Ω
DC resistance [Re]	5.6 Ω
Voice coil inductance [Le]	0.04 mH

Power Handling

100h RMS noise test (IEC 17.1)*	80 W
Long-term max power (IEC 17.3)*	400 W

*Filter: 2. order HP Butterworth, 4 kHz

Voice Coil and Magnet Data

Voice coil diameter	26 mm
Voice coil height	1.5 mm
Voice coil layers	2
Height of gap	2.5 mm
Linear excursion	± 0.5 mm
Max mech. excursion	± - mm
Unit weight	0.7 kg



TWEETER

D2608/913000

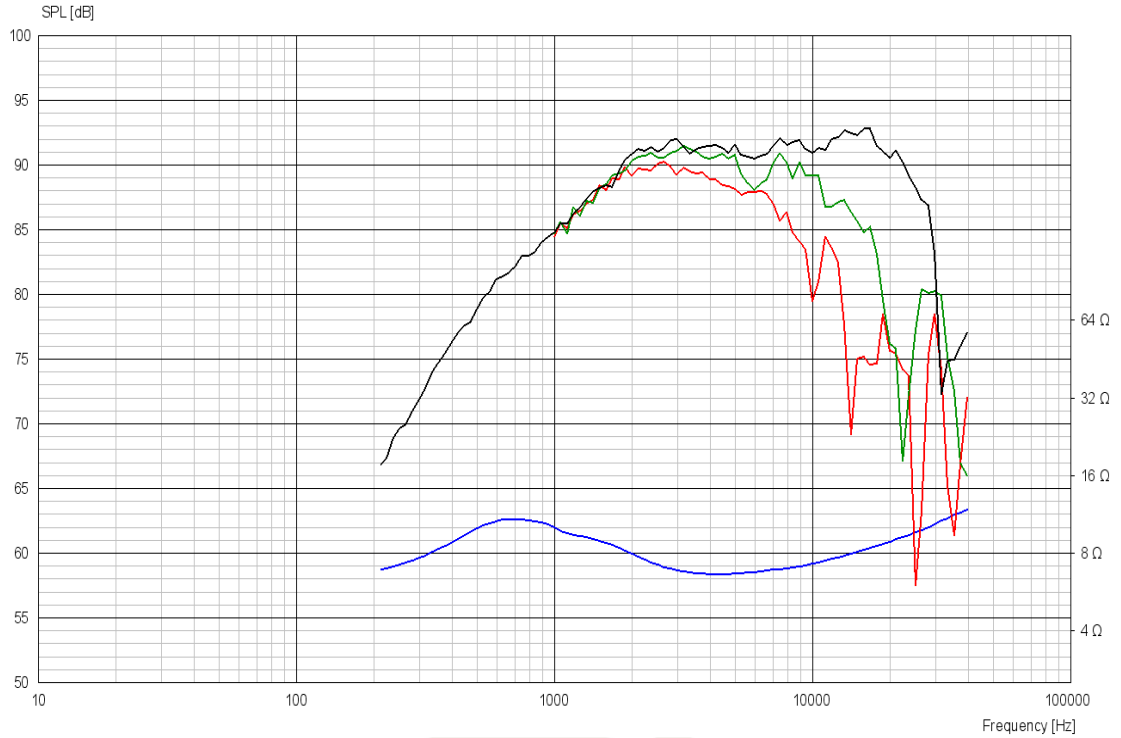

Advanced Parameters (Preliminary)



Electrical data:

Resistance [Re']	- Ω
Free inductance [Leb]	- mH
Bound inductance [Le]	- mH
Semi-inductance [Ke]	- SH
Shunt resistance [Rss]	- Ω

Mechanical Data

Force Factor [Bl]	- Tm
Moving mass [Mms]	- g
Compliance [Cms]	- mm/N
Mechanical resistance [Rms]	- kg/s
Admittance [Ams]	- mm/N